



AURRIGO

AUTOMOTIVE



AURRIGO

The company was established as RDM in 1993 and in September 2022 listed as a public company on the London Stock Exchange under the name Aurrigo International plc

Aurrigo *supplies world class products and engineering services to the automotive industry.

We have developed an excellent reputation and track record as a tier 1 supplier for high quality, innovative engineering solutions, supplying some of the world's largest OEM's and international tier 1's.

IATF 16949, ISO 9001 and ISO 14001 certified.

Aurrigo *has operations in the UK, Australia, Canada, Singapore and USA.

We offer clients component / System design, development and manufacturing together with ground up vehicle engineering development.

*Richmond Design & Marketing Limited which is part of Aurrigo International plc.

ELECTRONICS

Aurrigo* designs, develops and supplies Electronic Control Units (ECUs) for use in the automotive sector.

We employ engineers skilled in ECU hardware and software design, pcb layout, test and validation, together with experience of a wide range of vehicle ECU types

We also specialise in the redesign of existing ECUs as a result of current lack of semiconductor supply and to reduce costs and improve efficiency

Our quality control, customer service, technical support and continual investment, combined with a commitment to reducing costs, make us the right partner for your requirements

We take on all ECU projects, whether it is a system appraisal or a bespoke turnkey solution

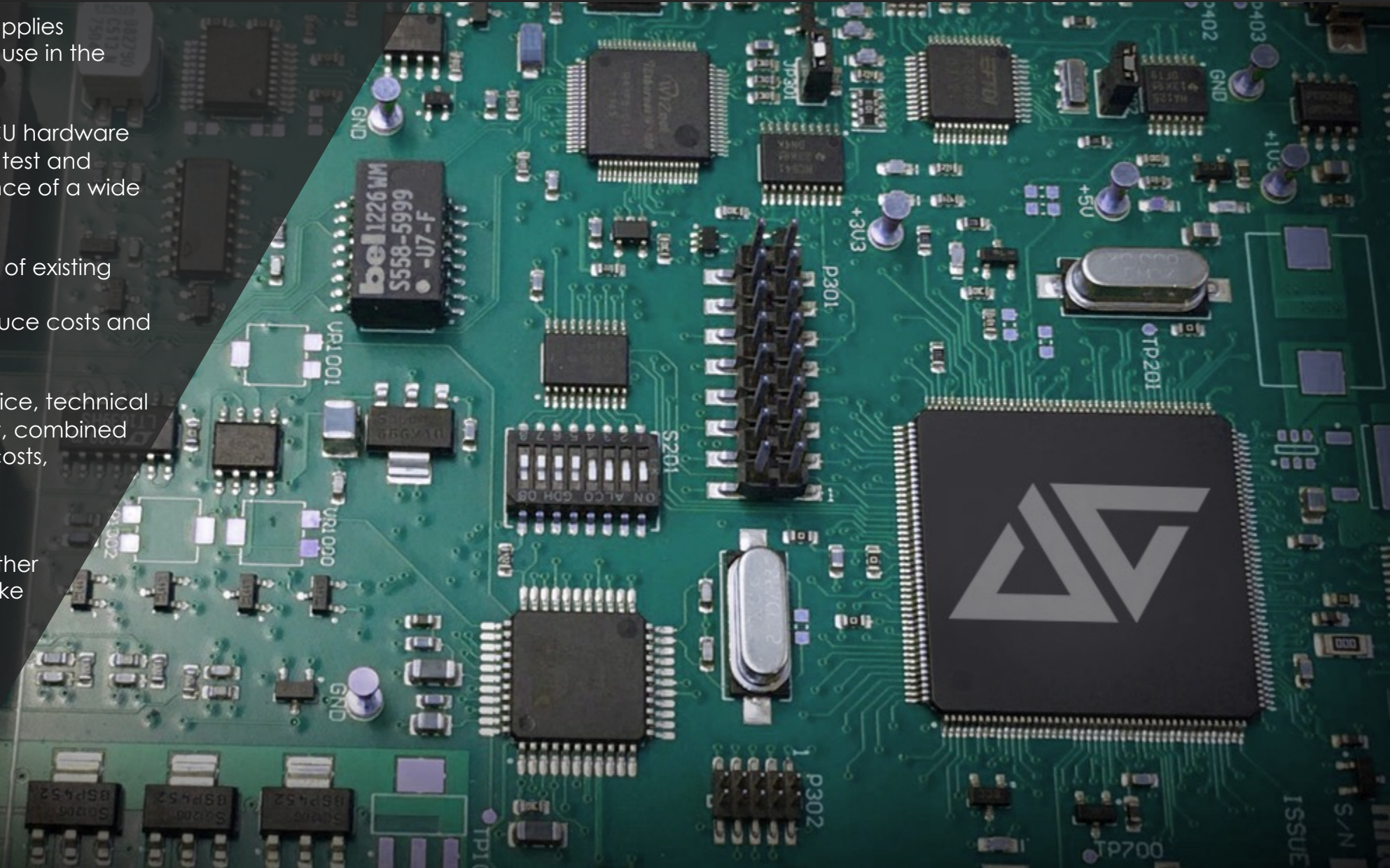

ELECTRONICS

CASE STUDY



OEM Centre console



Exhaust valve control
Developed for
major OEM



Map lamp used
in wide range
of OEM vehicles



OEM Pump
Controller
hardware

SOFTWARE/APPS

Aurrigo* develops software solutions, in-house, for a wide range of applications from embedded controllers through to mobile apps

Combined with our in-house electronics design and development capability, our software engineers can develop functionality and bring that through each development phase into final production

We are very familiar with design and development tool chains and then further into testing and safety using SPICE and ISO 26262 functional safety standard auditing

Aurrigo* develops its own autonomously driven vehicles for passenger and airport baggage movements so you can be sure that we develop software to the very highest safety standards

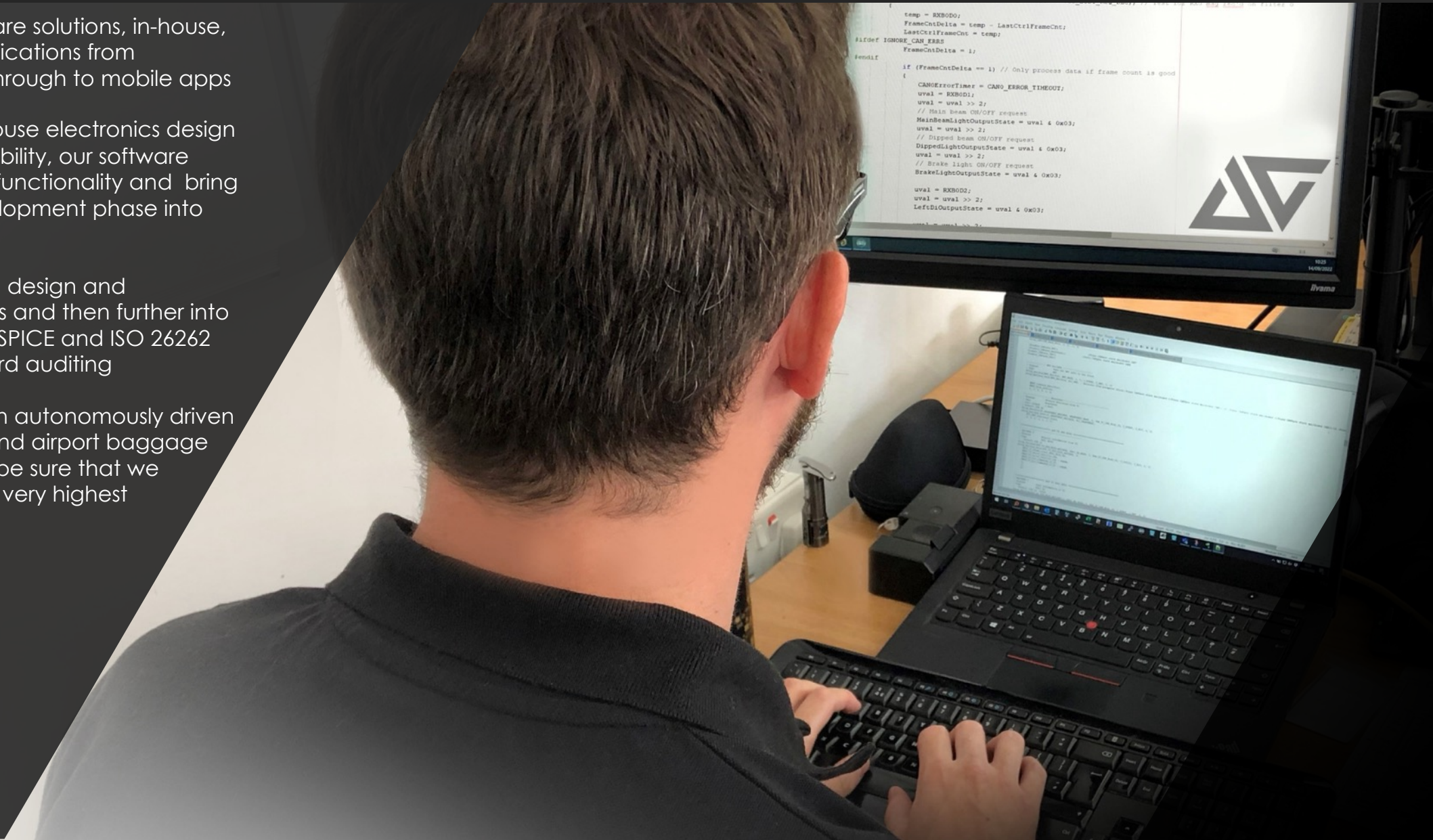

SOFTWARE/APPS

CASE STUDY

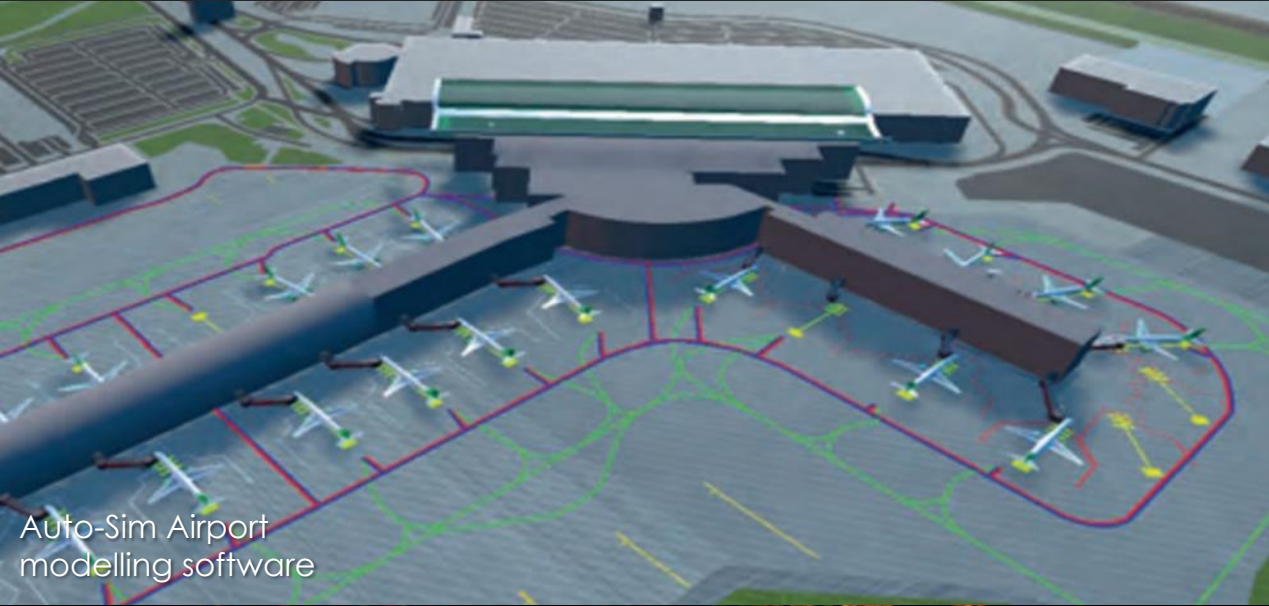

Auto-Sim Airport modelling software

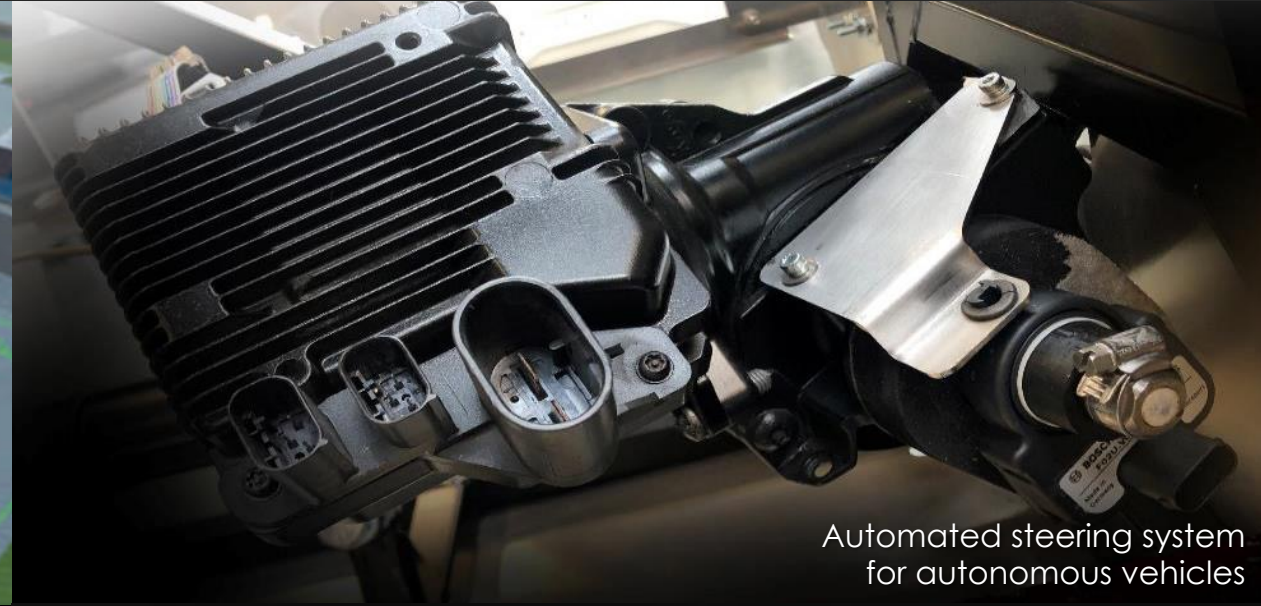

Automated steering system for autonomous vehicles

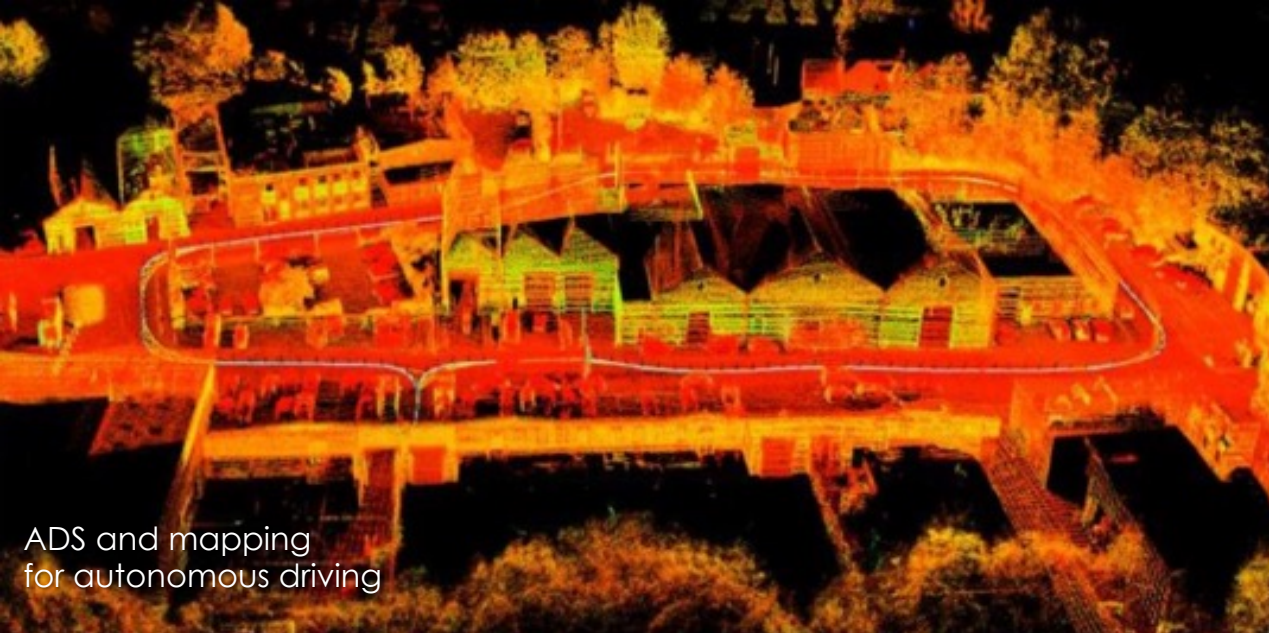

ADS and mapping for autonomous driving

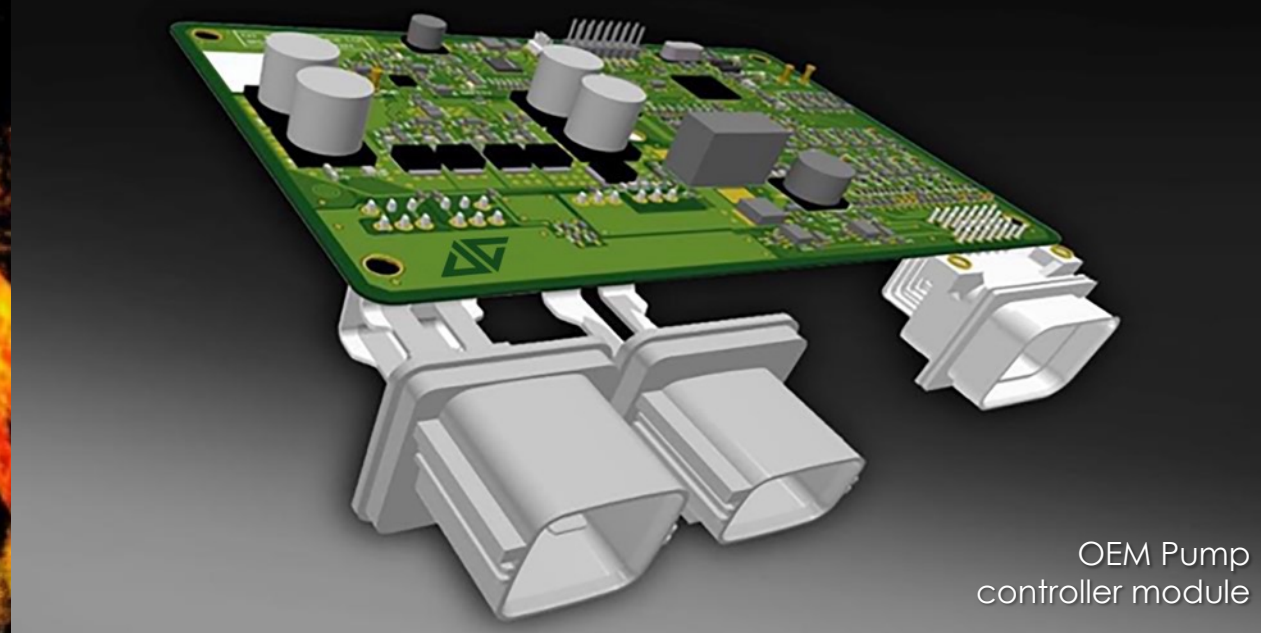

OEM Pump controller module

WIRING HARNESS DESIGN & MANUFACTURE



Aurrigo* designs & manufactures a wide range of wiring harnesses on a bespoke or low/medium volume basis through to high volume within our facilities in Coventry

We operate to the IATF 16949 global quality standard for the automotive industry, a prerequisite for dealing with many of the world's OEM vehicle manufacturers

Aurrigo* are fully conversant with PPAP, FMEA, IMDS & REACH procedures

WIRING HARNESS MANUFACTURE

CASE STUDY



Komax wiring machine



HV junction boxes

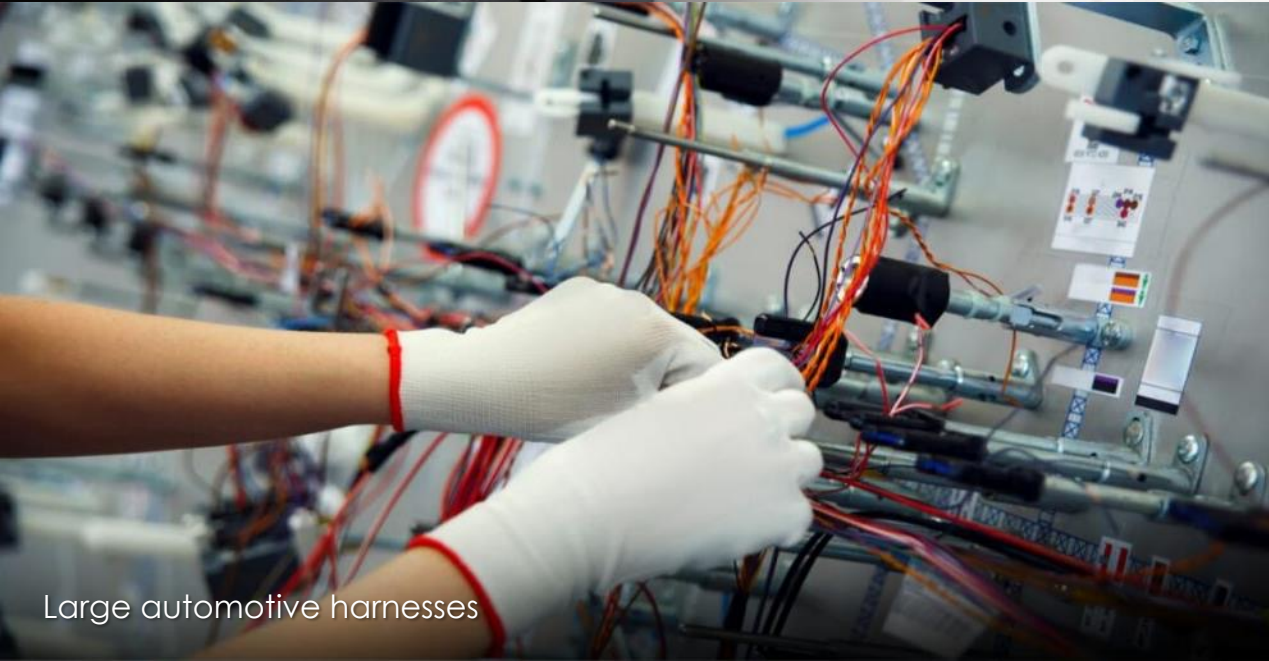

Large automotive harnesses



Harness link leads

DESIGN SERVICES

Aurrigo* designs & manufactures a wide range of products for the automotive and industrial markets

We have a dedicated design and engineering team that can bring your product ideas to life using sketch concepts, CAD renders, animations, exploded views and production CAD manufacturing solutions

We have the latest in-house CAD modelling software tools and can import and export data to a wide range customer systems

We operate to the IATF 16949 global quality standard for the automotive industry, a prerequisite for dealing with many of the world's OEM vehicle manufacturers

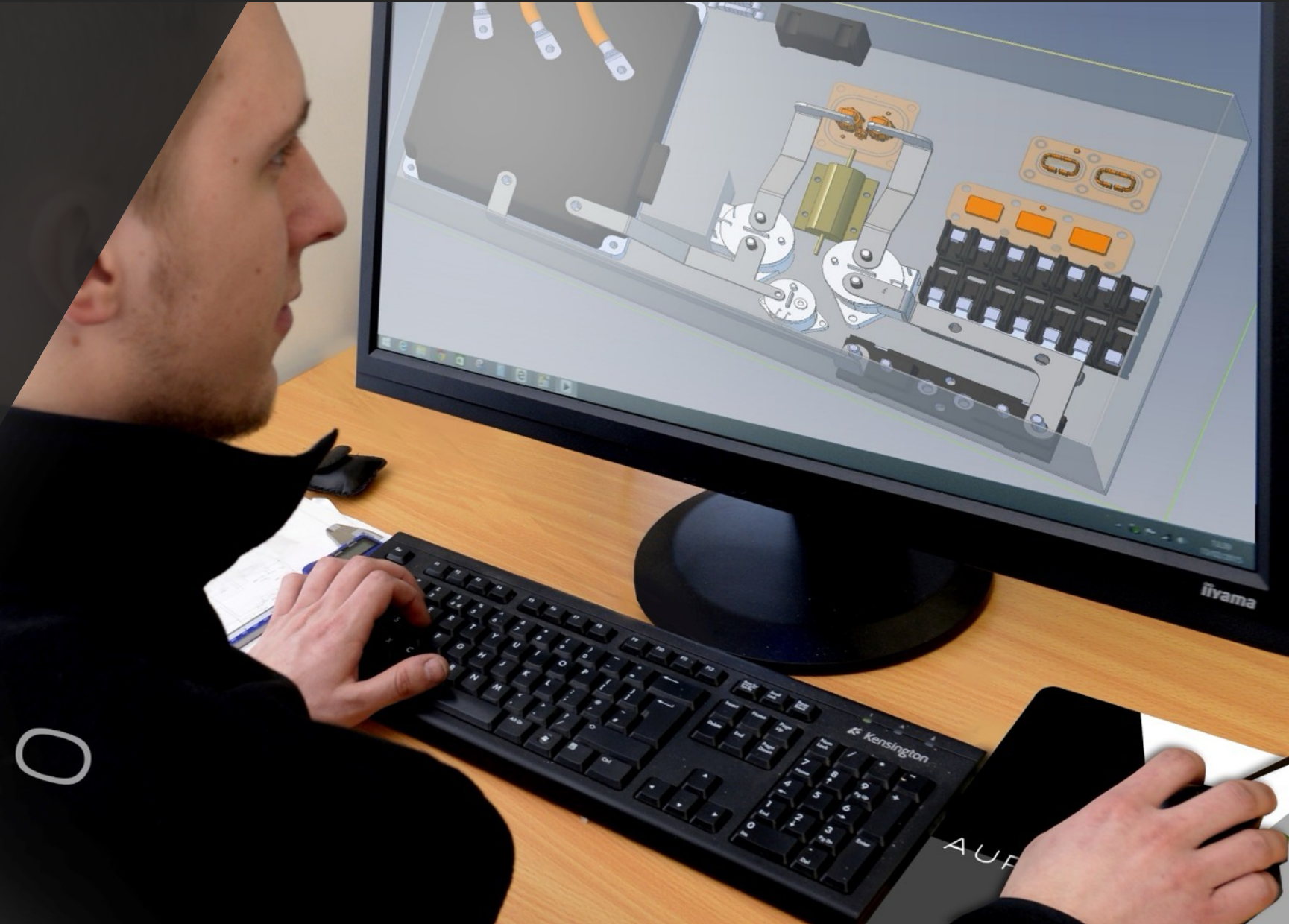

AURRIGO

AUF

DESIGN SERVICES

CASE STUDY

SA401397 - SUITCASE SUB-ASSEMBLY - MOHAIR - MSW 2021

Morgan pannier case

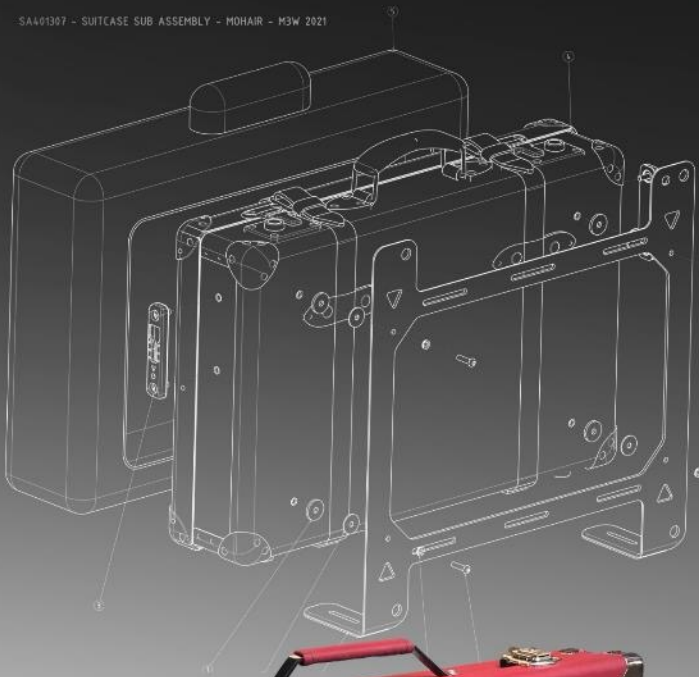

DESIGN SERVICES

CASE STUDY

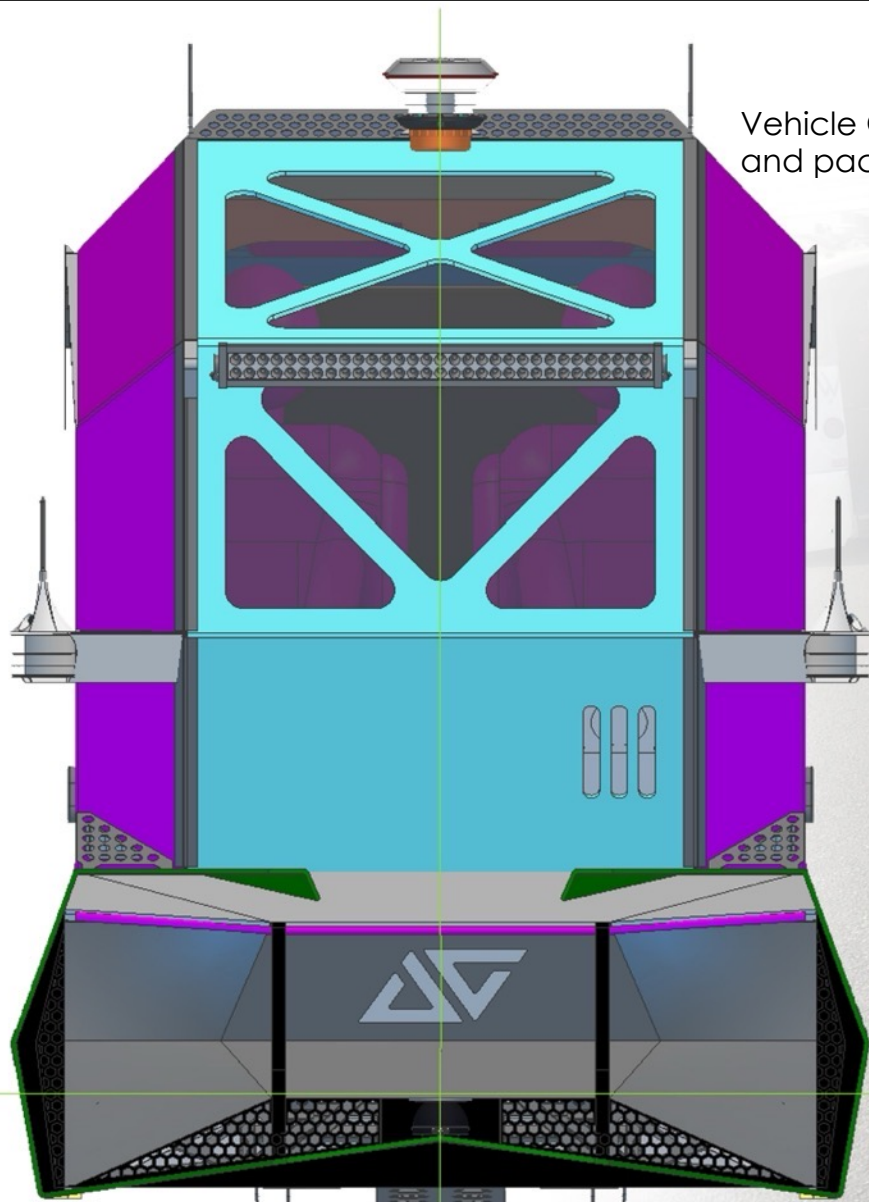

Vehicle CAD Design and packaging



Concept vehicles

DESIGN SERVICES

CASE STUDY

Initial hand developed sketch proposal

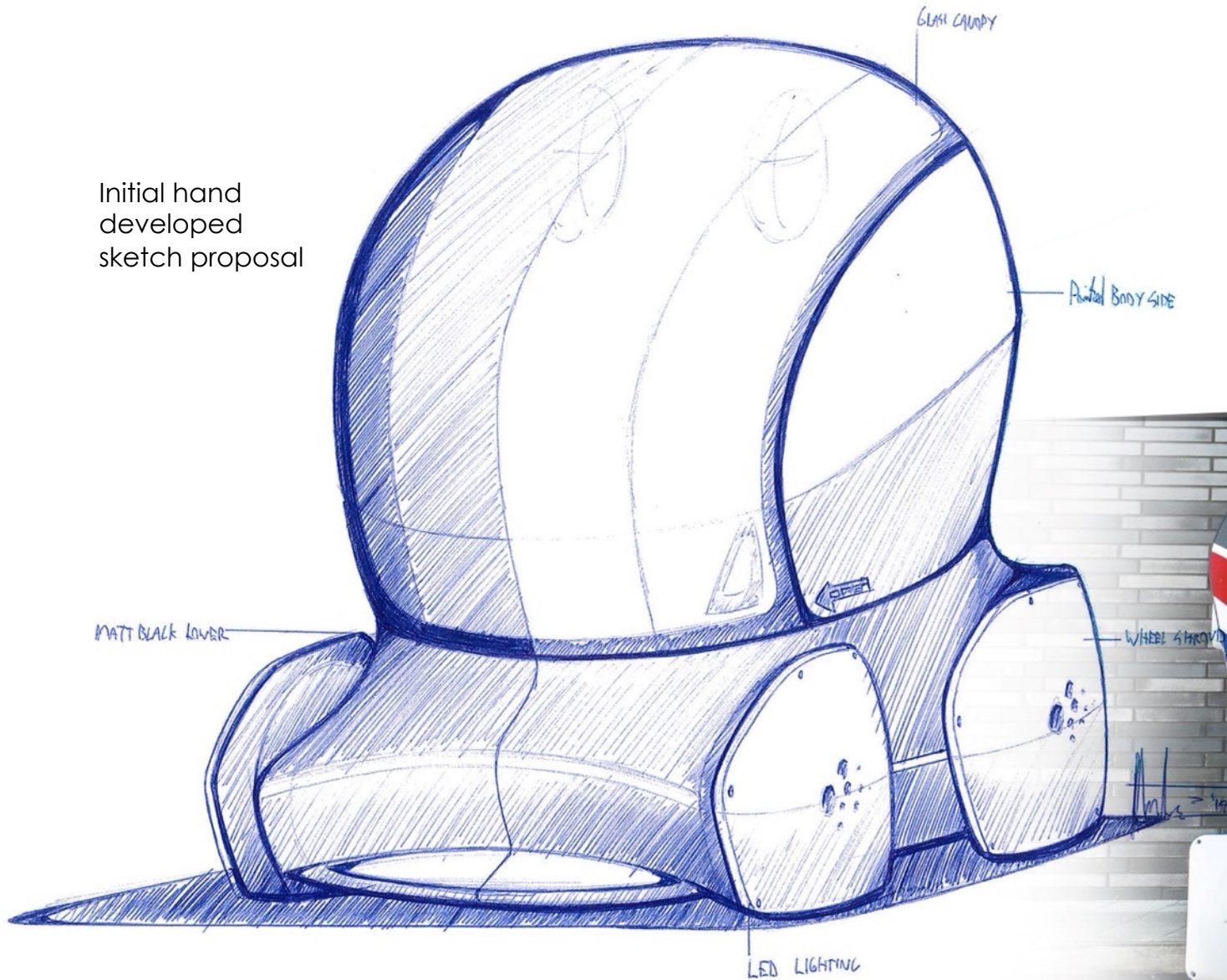

CAD model render and visualisation



Finished prototype



PROTOTYPE BUILD

Aurrigo has a large, and fully equipped vehicle build hall and a dedicated team of engineers and technicians

We can accommodate most vehicle sizes, providing our customers with a complete low volume build facility covering both conventional vehicles and EV's

We can also accommodate one of builds or part builds as well as show car development

We AUTO-DELIVER direct to you

Shop online today!

AURRIGO

AURRIGO AUTO-PATROL

AURRIGO

AKE18203 BA

BRITISH AIRWAYS

AURRIGO

AURRIGO



PROTOTYPE BUILD

CASE STUDY

JLR Leopard electric
Land Rover project



4EV offroad
electric vehicle



SnapCart
warehouse robot



Auto Patrol
security vehicle

TRIM DEVELOPMENT

Aurrigo* has a large trim shop facility capable of manufacturing and supporting prototype and production customer requirements

We have specialist equipment including embroidery facilities to produce the highest level of vehicle trimmed components

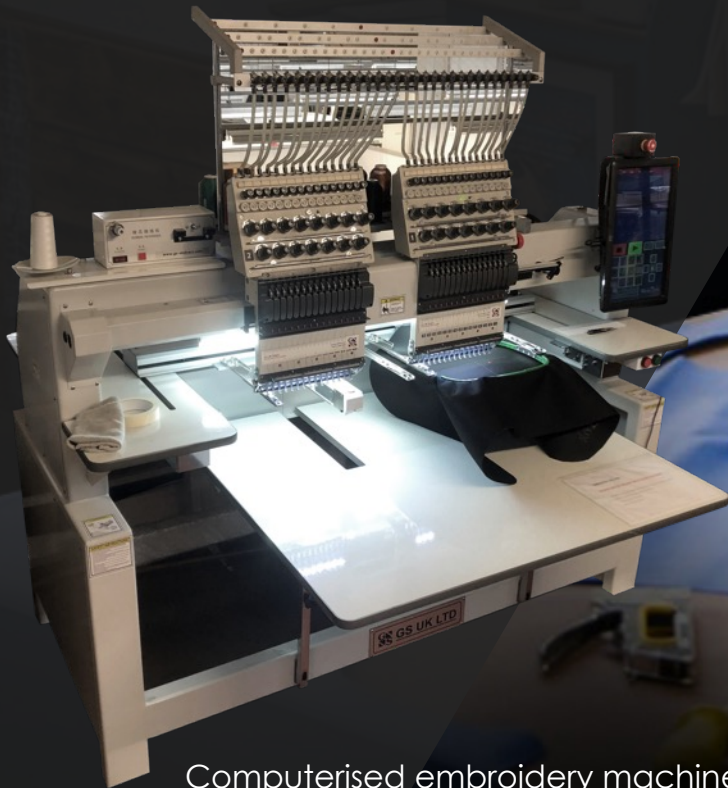

Computerised embroidery machine



TRIM DEVELOPMENT

CASE STUDY

Morgan 3 wheeler interior



CARBON FIBRE

Aurrigo* has a complete in-house carbon fibre product design and manufacturing capability

We can take a customer concept from sketch to reality and are experts in high quality 'A surface' components as well as bespoke products



CARBON FIBRE

CASE STUDY



Carbon dashboard



Aston Martin bonnet louvers

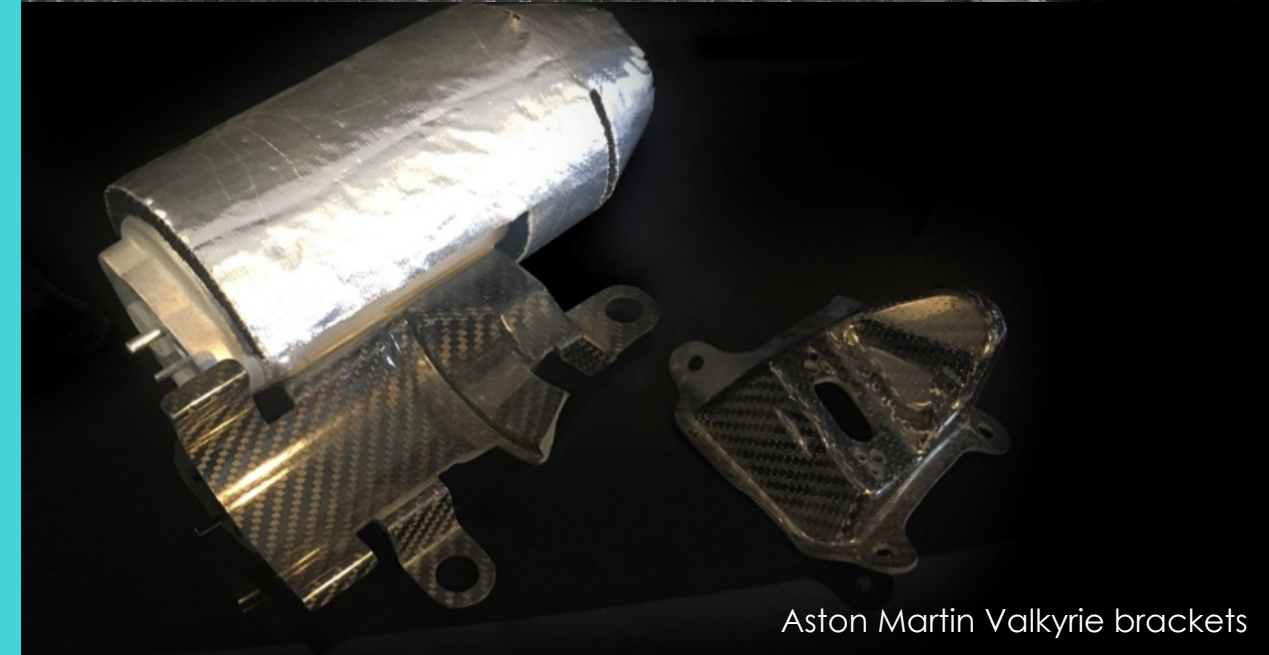

Aston Martin Valkyrie brackets



Morgan EV3 Junior monocoque

MACHINING & LASER ENGRAVING

Aurrigo* has a complete in-house design and manufacturing facility for a wide range of machined products

Also in-house we have laser engraving and marking enabling bespoke branded solutions to be created

Our CNC machines



Our laser engraving machine



MACHINING

CASE STUDY



Aluminium re-chargeable bespoke torches produced entirely in house for Jaguar Land Rover

OUR TECHNOLOGY IN VEHICLES



Aston Martin DBR22



Jaguar E-type continuation



Aston Martin Valkyrie



McLaren 720S



2022 Range Rover



Aston Martin DB5 continuation



2022 Range Rover Sport



Aston Martin Speedster



Morgan Super 3

CONTACT

No matter how big or small your requirements,
Aurrigo* can deliver!

We are proud to have worked with a diverse
range of satisfied customers for 30 years



A U R R I G O

Unit 33, Bilton Industrial Estate
Humber Avenue
Coventry
CV3 1JL

Tel: 02476 635818

Email: ask@Aurrigo*.com